

DALI

# OPTICON MK2

WHITE PAPER

DALI OPTICON MK2 SERIES

DALI HYBRID  
TWEETER MODULE

DALI

IN ADMIRATION OF MUSIC



## 1. DALI OPTICON MK2 – PASSION FOR DETAIL

The OPTICON series has been at the heart of the DALI range for over five years and has brought exceptional DALI performance into the homes of countless music lovers and audiophiles. But the time has come for the OPTICON to benefit from some new ideas and technologies, and to be refreshed with a new aesthetic. Welcome to the DALI OPTICON MK2.

Effectively updating and improving such a well regarded high performance series as the OPTICON is a careful balancing act. How to enhance the existing engineering, aesthetics and performance without degrading or even eradicating the qualities that worked so well the first time around? The answers to that conundrum are numerous, and range from subtle revisions to more fundamental changes, but they have all been implemented the DALI way, with a continual focus on music reproduction, thoughtful design, stylish aesthetics, quality of manufacture and use of the latest technologies and ideas.

As with the original OPTICON series, an important element of the OPTICON MK2 is that it remains fully Danish in manufacture; built at our factory in Denmark from components either produced in-house, or sourced from the best specialist manufacturers locally and further afield.

Just like its predecessor, the OPTICON MK2 is a speaker series that majors on clear, undistorted, enjoyable and coherent audio; perfectly complementing music, radio, streaming, TV or movie sources. A speaker series that caters to every requirement with compact stand or wall mount options, slim to more substantial floor stand options, and a centre channel option too. The OPTICON MK2 series offers a speaker for every room and every occasion.

## 2. The OPTICON MK2 Series

The DALI OPTICON MK2 series comprises six models and marks the point in the DALI passive speaker range where both performance and engineering ambition take a real step up and begin to speak the language of specialist, high-end hi-fi. OPTICON MK2 also introduces the renowned DALI hybrid tweeter, die-cast aluminium driver chassis, full SMC driver pole-pieces, and in-house manufactured enclosures.

Each OPTICON MK2 model is built around in-house manufactured SMC based bass/midrange drivers, and employs either a DALI soft dome tweeter or the hybrid soft dome and ribbon tweeter for which DALI has become so

well known. OPTICON MK2 models are available in three new finishes; satin white, satin black, and tobacco oak\*. Grilles are covered with furniture grade cloth in black for the two darker enclosure options and light grey for the white enclosure option. The OPTICON MK2 models are described in the following paragraphs.

\* The OPTICON 8 MK2 is available in Satin Black Ash and Tobacco Oak only.



Cabinet: Satin Black  
Grill: Black

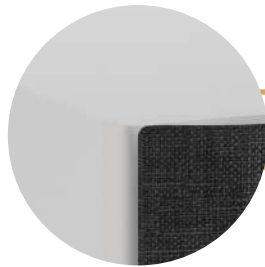

Cabinet: Satin White  
Grill: Light Grey



Cabinet: Tobacco Oak  
Grill: Black



OPTICON  
1 MK2

OPTICON  
2 MK2

OPTICON  
6 MK2

OPTICON  
8 MK2

OPTICON  
LCR MK2

OPTICON  
VOKAL MK2



### **OPTICON 1 MK2**

The OPTICON 1 MK2 is a compact stand mount speaker designed to be installed close to room boundaries or wall mounted in modest listening spaces. Its drivers comprise a 4¾" Wood Fibre diaphragm, SMC magnet bass/midrange unit and a newly designed 29mm soft dome tweeter derived from that employed in the CALLISTO series. The Dual Flare reflex loaded 5 Litre enclosure enables the OPTICON 1 MK2 to deliver remarkable bass performance for its size that integrates perfectly with the inherent midrange and high frequency quality of its drivers. The OPTICON 1 MK2 is supplied with a simple keyhole slot wall mounting bracket.

### **OPTICON 2 MK2**

The OPTICON 2 MK2 is a mid-sized stand mount speaker. Its 6½" Wood Fibre diaphragm, SMC magnet bass/midrange driver and 10 Litre enclosure enables it to achieve greater low frequency bandwidth and volume level than its smaller sibling. It features the same CALLISTO derived 29mm soft dome tweeter as the OPTICON 1 MK2. The OPTICON 2 MK2 is a natural for high performance stand mount audio in compact to medium size listening spaces where it has room to breathe and deliver its dynamic and explicitly defined performance.





## OPTICON 6 MK2

The slim, floor-standing OPTICON 6 MK2 is the entry point in the OPTICON MK2 series for the renowned DALI hybrid soft dome and ribbon tweeter. The hybrid tweeter offers a significant advance in high frequency resolution and has been improved for OPTICON MK2 by incorporating the CALLISTO derived 29mm dome alongside a 17mm x 45mm ribbon element in a re-engineered, cast aluminium faceplate. OPTICON 6 MK2 low frequencies and midrange are handled by twin 6½" Wood Fibre diaphragm, SMC magnet bass/midrange drivers, the lower one of which is gradually attenuated into the midrange band.

The OPTICON 6 MK2 offers optional bi-wiring to enable its bass/midrange and high frequency sections to be connected independently. Twin bass drivers, Dual Flare reflex loading, and the increased internal volume provided by its floor standing enclosure enable the OPTICON 6 MK2 to achieve significantly greater low frequency extension and bass volume level than the stand mount OPTICON MK2 systems. And it combines that bass performance with brilliant, midrange clarity and the sparkling high frequencies that are characteristic of the DALI hybrid tweeter.

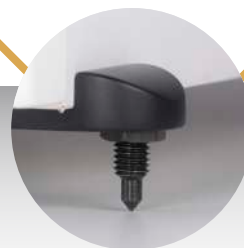

The OPTICON 6 MK2 is supplied with cast aluminium foot components that can be fitted with either black chrome plated floor-spikes or, when installed on sensitive floor surfaces, vibration damping pads. Tools for attaching the foot castings and spikes are included.

## OPTICON 8 MK2

The large-scale, floor-standing OPTICON 8 MK2 is the powerhouse of the new OPTICON MK2 series. It is the sole three-way system in the series. It combines two 8" Wood Fibre diaphragm, SMC magnet bass drivers with a 6½" Wood Fibre diaphragm, SMC magnet system midrange driver. The OPTICON 8 MK2 offers optional bi-wiring to enable its bass and midrange/high frequency sections to be connected independently. The driver array of the OPTICON 8 MK2 locates the midrange and hybrid tweeter drivers between the two widely spaced bass drivers. This is done firstly in order to position the mid and high frequency drivers near typical seated ear height, and secondly to take advantage of the smoother low frequency room response that results from spaced bass drivers. The OPTICON 8 MK2 driver array helps make room positioning easier. Above the midrange driver, the OPTICON 8 MK2 incorporates a DALI hybrid tweeter that combines the new, CALLISTO derived 29mm soft dome driver alongside a 17mm x 45mm ribbon element.

The OPTICON 8 MK2 enclosure incorporates separate internal sections for each driver with non-parallel dividing panels suppressing internal resonance and also significantly aiding enclosure rigidity. Each low frequency section is fitted with its own Dual Flare reflex port. Thanks to its size and true three-way format, the OPTICON 8 MK2 offers a level of performance unavailable from any other OPTICON model. It combines immense low frequency bandwidth, volume potential and dynamic accuracy with the extraordinary detail and clarity that arises from the use of a dedicated midrange driver. High frequencies from the hybrid tweeter are explicitly detailed and informative yet simultaneously smooth and endlessly listenable.

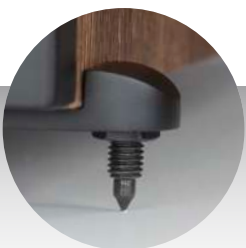

The OPTICON 8 MK2 is supplied with cast aluminium foot components that can be fitted with either black chrome plated floor-spikes or, when installed on sensitive floor surfaces, vibration damping pads. Tools for attaching the foot castings and spikes are included.



The OPTICON 8 MK2 is available in Satin Black Ash and Tobacco Oak.

## OPTICON LCR MK2

The OPTICON LCR MK2 combines the best of all the OPTICON MK2 technologies in a low profile, wall mounted multi-purpose enclosure that can work wonders in left channel, right channel and centre channel roles. The OPTICON LCR MK2 has everything covered – from conventional stereo through TV audio to multi-channel home theatre applications. Its ingenious, wall assisted reflex port system works in synergy with its 6½" Wood Fibre diaphragm, SMC magnet bass/midrange driver and its rotatable hybrid tweeter module to deliver an all round performance that truly belies its compact dimensions. With airy high frequencies, expressive midrange and surprisingly extended bass, the OPTICON LCR MK2 is an on-wall speaker that delivers genuine hi-fi performance.



## OPTICON VOKAL MK2

The OPTICON VOKAL MK2 brings a 6½" Wood Fibre diaphragm, SMC magnet bass/midrange driver and the DALI hybrid tweeter together in an enclosure format designed specifically for centre channel applications in multi-channel audio-visual systems. The OPTICON VOKAL MK2 enclosure dimensions and proportions are specifically configured to enable its installation in audio-visual furniture units, and its front facing reflex ports mean that even fully enclosed mounting is feasible. The OPTICON VOKAL MK2 is specifically voiced to play the centre channel role, but at the same time it displays all the characteristic qualities that enable it to dovetail perfectly in a full OPTICON MK2 audio visual system.

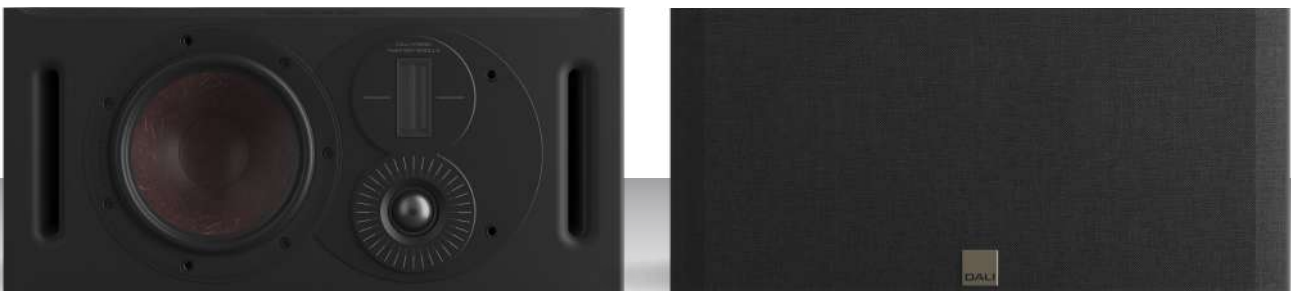



### 3. OPTICON MK2 Bass and Midrange Drivers

The OPTICON MK2 bass and midrange drivers were designed with a consistent focus on the DALI audio principles of low-loss, low distortion and low colouration. The ideal driver plays only what the amplifier requires, with nothing added and nothing subtracted, and at DALI we strive to design and manufacture drivers that approach the ideal as closely as possible.

Every component in each OPTICON MK2 bass/mid driver is carefully designed for its positive contribution towards ideal performance. The EPICON derived diaphragms are made from a mix of paper and wood fibre that ensures minimal break-up resonance and gives the diaphragms their distinctive colour. They are terminated by rubber surrounds chosen for their soft and very flexible mechanical properties that enable free movement with minimal low frequency damping. In any bass/mid driver, it is the magnet and voice-coil system that is best placed to control and damp diaphragm movement. The job of the surround is simply to dissipate, without resonance, the vibrational energy flowing outward in the diaphragm; the less it interferes with low frequency damping the better. The OPTICON MK2 bass and midrange driver chassis are manufactured in die-cast aluminium that provides extremely high rigidity and low resonance along with minimal extraneous influence on the internal magnet system. The mechanical design of the chassis is specifically engineered

to provide minimal impedance to airflow while at the same time enabling extremely tight mechanical bonding with the speaker enclosures.

The OPTICON MK2 bass/mid driver magnet system consists of a large ferrite ring magnet surrounding a pole piece manufactured entirely of the unique DALI SMC material. The pole piece and the ferrite magnet are secured between soft iron front and back plates to create the appropriate magnetic field for the voice-coil.





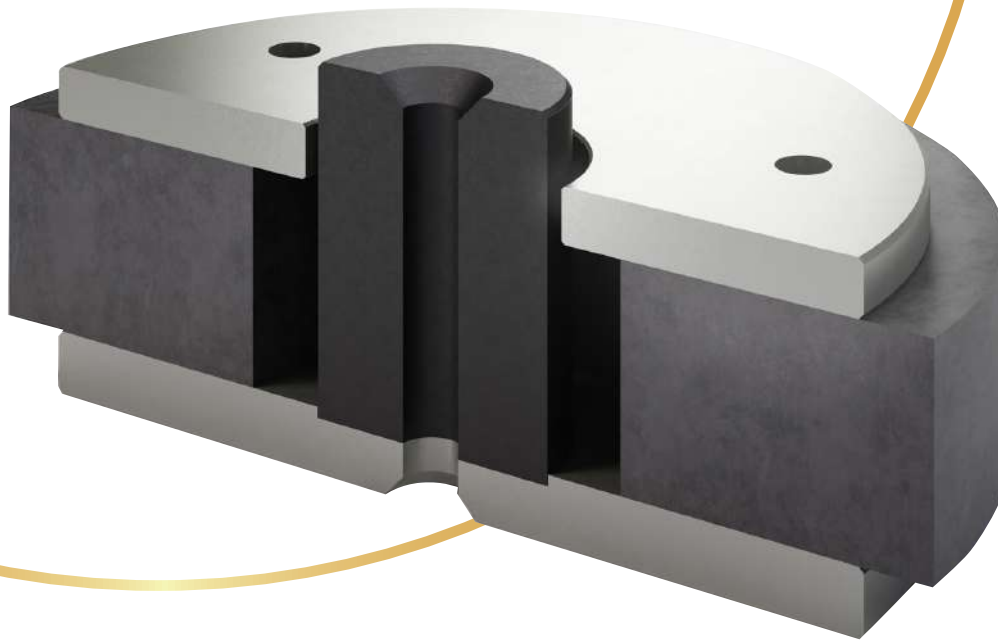

DALI SMC (Soft Magnetic Compound) is a coated magnet granular material that can be formed to almost any desired shape and has many advantages used in driver magnet systems. SMC's unusual combination of very high magnetic permeability and very low electrical conductivity is exactly what is required for driver magnet systems and results in a significant reduction of electro-acoustic distortion.

SMC works primarily by minimising eddy currents in the magnet system pole piece. Eddy currents arise through the movement of the voice-coil around the pole-piece and create a secondary magnetic field that modulates the input signal and results in increased levels of harmonic distortion. In addition to reducing distortion through eddy current reduction however, SMC also improves flux linearity within the magnet system, reduces magnetic hysteresis, and minimises the variation of voice-coil inductance with position. All of these SMC benefits together produce a significant subjective reduction of low-level detail masking and colouration.

The bass and bass/mid drivers in each OPTICON MK2 system are finely adjusted in terms of mechanical, magnetic and electrical parameters to work with each speaker's enclosure volume, internal damping and Dual Flare port tuning to result in a low frequency response profile ideally suited to their likely installation. For example, where the OPTICON 1 MK2 offers a relatively early but gradual

low-frequency roll-off suited to installation in compact listening spaces, the OPTICON 8 MK2 offers a much more extended low frequency profile that suits installation in large listening spaces with more distant room boundaries. These considerations of low frequency voicing have been revised in the OPTICON MK2 series to provide improved integration with listening spaces and to take further advantage of the newly introduced Dual Flare reflex ports.

Along with the optimisation of bass driver low frequency parameters, OPTICON MK2 midrange driver characteristics are engineered to optimise integration with the soft dome and hybrid tweeters. In particular, the midrange response shape of the Wood Fibre diaphragms contributes to the overall filter characteristics of the driver and crossover together. The driver and crossover effectively work as one.



The fine grain SMC material is an important building material in the materialization of the high performance magnet system.

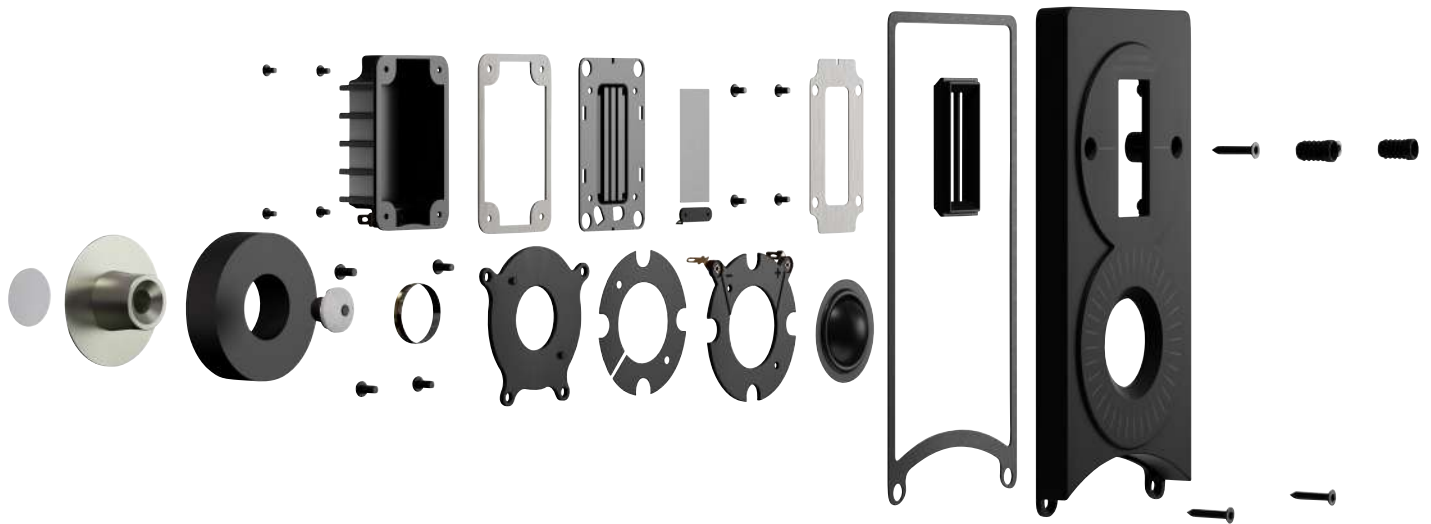

## 4. OPTICON MK2 Soft Dome and Hybrid Tweeters

### SOFT DOME TWEETER

The CALLISTO derived 29mm soft dome tweeter used in all six OPTICON MK2 systems is a new design that offers significant advances over the two different soft dome tweeters used in the previous OPTICON series. Its relatively small increase in diameter over the previous 28mm tweeter may seem a minor detail, however it results in a significant increase in dome radiating area which means lower distortion, higher power handling, and an ability to operate at lower frequencies. Use of the same soft dome tweeter across all six OPTICON MK2 models not only results in consistency of tonal character, but also enables similar crossover topology to be used on each model so providing consistency of dispersion characteristics.

The new OPTICON MK2 soft dome tweeter enables crossover frequencies as low as 2kHz to be safely employed with no risk of distortion or power handling limitations. The tweeter is equipped with high flux saturation and very low-viscosity ferro-fluid in its magnet gap which provides increased power handling and resonance damping without slowing the impulse response speed of its ultra-light coated diaphragm.

### HYBRID TWEETER

DALI has a long and successful tradition for engineering and integrating hybrid tweeter modules comprising a soft dome element working together with a ribbon element. The OPTICON 6, 8 LCR and VOKAL MK2 systems employ a new hybrid tweeter design that marries the CALLISTO derived 29mm soft dome element with a custom designed 17mm x 45mm ribbon element mounted on a cast aluminium faceplate. The faceplate incorporates dispersion control detailing, and the ribbon diaphragm itself is isolated from internal enclosure pressure changes via a damped and braced rear chamber.

The hybrid tweeter system is configured such that the ribbon element begins to contribute from 10kHz upwards; just as the response of the soft dome element is beginning slowly to fall away and become more directional. The ribbon element both extends the system frequency response towards 30kHz and contributes to keeping high frequency horizontal dispersion wider than would otherwise be the case. The new hybrid tweeter literally offers the best of both worlds – the clarity, speed and dynamics of a dome tweeter, with the very high frequency detail and smooth finesse of a ribbon tweeter.



CALLISTO tweeter for illustrative purpose.

## 5. OPTICON MK2 Reflex Ports

All six OPTICON MK2 models are reflex loaded speakers. Reflex loading employs the otherwise unused acoustic output from the rear of a bass driver to extend low frequency bandwidth and increase low frequency power handling. It achieves this by using an appropriately tuned low frequency resonance (the reflex port) effectively to reverse the phase of the rearward output of the bass driver so that it adds to the forward output. Reflex loading is not a 'free lunch' however and if not carefully considered, with the port tuning frequency and set exactly right for the drivers and enclosure volume, it can result in unnaturally emphasised and audibly 'slow' bass. For all the OPTICON MK2 models we revisited the port tuning in the context of all the MK2 revisions to ensure that the subjective bass performance of each one is absolutely optimised for its likely installation application.

The design of speaker reflex ports is a far more complex problem than perhaps it appears, and with the OPTICON 1, 2, 6 and 8 MK2 we took the MK2 opportunity to incorporate our Dual Flare port technique. The problem with reflex ports is that to work optimally, the airflow through them must remain smooth and laminar (like a gently flowing river, rather than rapidly churning white water), but as bass volume levels increase, port turbulence can quickly arise, with potentially audible compression and distortion as a result.

The newly introduced OPTICON MK2 Dual Flare technique brings port design into the realm of aerodynamics with exit and entry flares carefully designed to minimise turbulence at the airflow rate expected from the port diameter and tuning frequency. Dual Flare enables OPTICON MK2 reflex ports to remain laminar and work effectively to reinforce low frequency performance to a significantly higher volume level than would otherwise be the case.

The reflex ports employed in the OPTICON LCR and VOKAL MK2 are not Dual Flare designs, however their ports are no less carefully considered. In the case of the OPTICON VOKAL MK2, it employs twin, forward facing letterbox style reflex ports configured to enable the system to be enclosed in furniture units. Not only does its enclosure format not provide enough space for Dual Flare, port flaring is less critical on a system designed primarily for voice reproduction.

In the case of the OPTICON LCR MK2, its on-wall installation requires an entirely different reflex port approach. Its reflex port exits are located in the rear panel and engineered to vent in parallel to the wall. The rear wall surface effectively becomes integral to the port tuning and exit flaring.



## 6. MANUFACTURING IN PAIRS

There's many respects in which DALI stands out among the crowd of HiFi speaker manufacturers, but one in particular is our approach to pair matching – in terms of both acoustics and finish quality.

DALI has highly effective quality assurance systems that ensure tight tolerances and minimal deviation from reference standards, but not even optimal quality control can always fully regulate some of the natural materials fundamental to speaker manufacture – the colour nuance of veneers, for example, will vary slightly over time.

So DALI manufacturing processes are designed around the idea that speakers used and enjoyed in pairs should also be built as pairs! So our process ensures that stereo pairs of speakers are built and tested sequentially by a

single manufacturing technician, using components taken in the same order from the same batch. It's a process that not only helps ensure ultimate acoustic pair matching, but it means also that the small details that make such a difference to quality and pride of ownership are properly attended to.

Examine a pair of HiFi speakers from many manufacturers and you'll almost certainly see that they each have different serial numbers, often some numerical distance apart. This indicates that manufacturing may have taken place months apart; perhaps even on different production lines. Examine a pair of DALI speakers however and you'll see that they carry the same serial number, with just a simple extension to denote Left or Right. It's a simple approach that costs very little, yet it results in huge benefits for the customer.



## 7. OPTICON MK2 Crossover

Integrating the output of the separate drivers in a multi-driver speaker system is the primary job of the crossover, but the crossover is also fundamental in defining both the wide-band and fine tonal balance of the speaker - its characteristic subjective 'voice'. Crossovers are a DALI speciality and we habitually spend numerous R&D hours meticulously fine tuning and optimising each crossover element to squeeze every grain of performance out of each speaker system.

For all the OPTICON MK2 models we returned to first principles and started afresh with crossover design to ensure that the theoretical benefits of the new drivers would be fully realised in the subjective performance of the systems - working with the natural response characteristics of the drivers rather than against them.

We also worked hard to make the filter topology as simple as possible with the minimum of components between the amplifier and drivers. Furthermore, as part of the crossover design exercise, we made sure to upgrade the quality of some individual crossover components – lower loss capacitors in particular. The result is a noticeable increase in overall coherence, detail and precision across the entire OPTICON MK2 series.

The crossover assemblies in each OPTICON MK2 speaker are located internally adjacent to the terminal panels in order to shorten signal paths, and on the OPTICON 6 and 8 MK2 models the terminal panels incorporate optional bi-wiring facilities. The connection terminals on all OPTICON MK2 models are gold plated to ensure long term reliable connections.

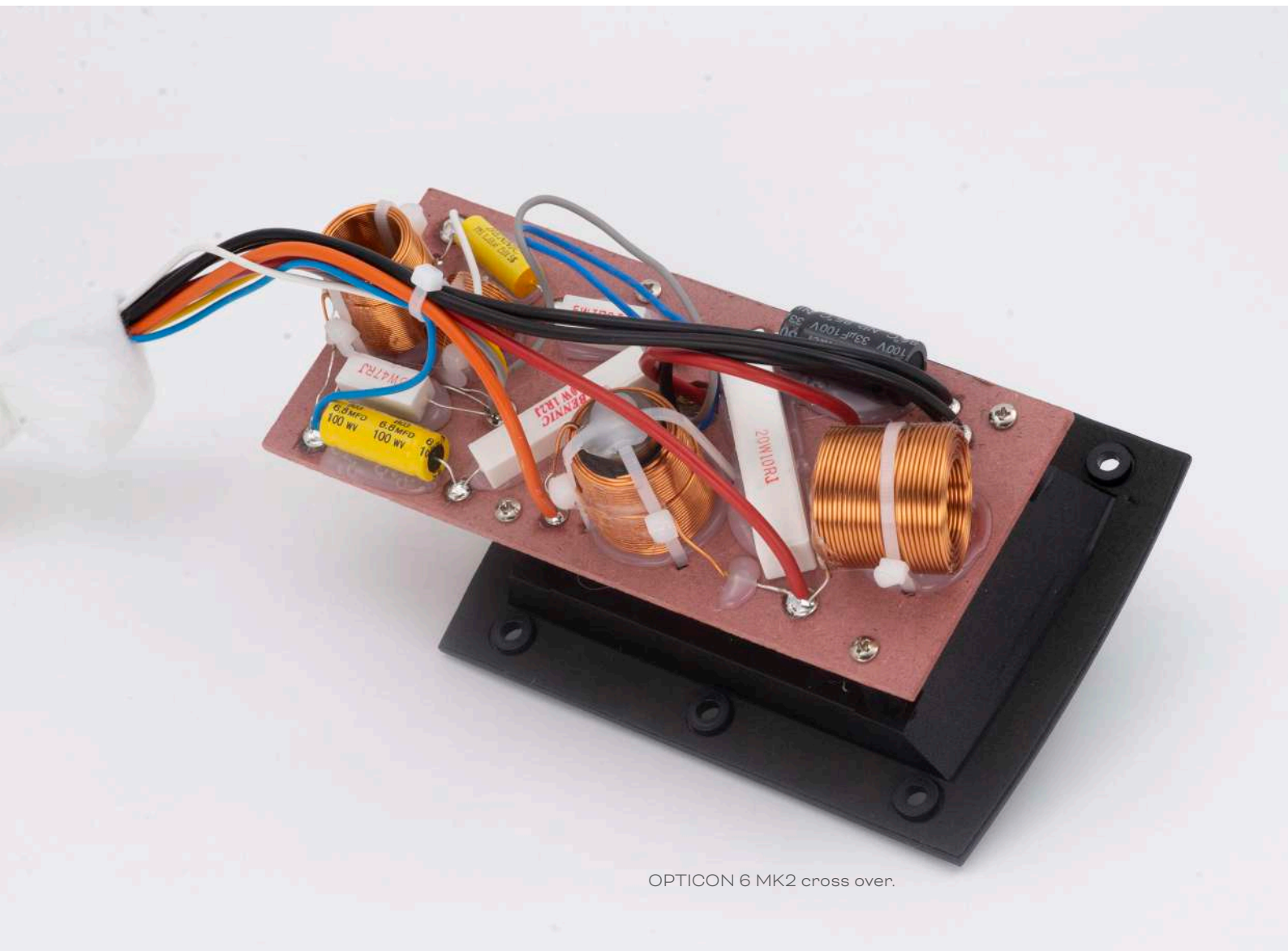

OPTICON 6 MK2 cross over.

## 8. OPTICON MK2 Cabinets



Manufacture of the OPTICON MK2 series has been retained firmly at DALI in Denmark. Our in-house woodworking facility handles everything from cutting and routing the MDF enclosure panels to applying the surface finishes and constructing the enclosure carcasses. Driver and crossover installation and final test and quality approval on each and every speaker is also handled on our own assembly lines.

Each OPTICON MK2 enclosure is designed to optimise rigidity and minimise panel resonance. The OPTICON MK2 25mm thick front baffles provide massively rigid foundations for the drivers, and the floor standing OPTICON MK2 models employ extra internal bracing further to ensure rigidity and practically eliminate panel resonance. To ensure the most secure attachment on the bass/midrange drivers and their integration with the enclosure, their five mounting holes are located along the arms of their driver chassis. Furthermore, the internal profile of the bass/midrange driver baffle cut-outs is relieved between the fixing points to provide clearer airflow space behind the driver diaphragms. The new OPTICON MK2 cast aluminium tweeter faceplates are held securely in place with four or six screws to minimise the possibility of vibration and resonance.

OPTICON MK2 front grilles are attached via inserts integrated elegantly into the tweeter and bass/mid driver faceplates and chassis. This style of attachment secures the grilles in a manner that eliminates the possibility of resonance and also leaves the baffle surface aesthetically clean without unnecessary and distracting visual features.

The OPTICON MK2 finishing laminates are among the finest available and extensive testing was undertaken to ensure that their surfaces and the enclosure joints will withstand significant ambient temperature and humidity changes. And through strict in-house control of every aspect of manufacture, the OPTICON MK2 series achieves levels of fit and finish typically found only at significantly higher price points.





## 9. OPTICON MK2 Update Summary

- Fresh and elegant aesthetic with new satin white, satin black and tobacco oak finish options matched with new furniture grade grille fabrics.
- New Woofers and Midrange drivers with SMC technology and DALI EPICON derived Wood Fibre Diaphragms.
- New, larger diameter in-house designed and manufactured soft dome tweeter derived from the DALI CALLISTO.
- Hybrid, soft dome and ribbon tweeter on the OPTICON 6 -, 8- , LCR- and VOKAL MK2.
- New die-cast aluminium tweeter faceplates.
- DALI Dual Flare reflex ports for reduced port turbulence and noise.
- Re-engineered crossovers incorporating upgraded, low-loss components.
- Optional bi-wire connection facilities on OPTICON 6 MK2 and 8 MK2.
- Tonal balance revoiced to maximise the subjective benefits of the MK2 revisions.

# Technical specifications

	<b>OPTICON 1 MK2</b>	<b>OPTICON 2 MK2</b>	<b>OPTICON 6 MK2</b>
Frequency range (+/-3 dB) [Hz]	62 - 25.000	59 - 25.000	49 - 30.000
Sensitivity (2.83V/1m) [dB]	85	86,5	88
Nominal Impedance [ohm]	4	4	4
Maximum SPL [dB]	105	107	110
Recommended Amplifier Power [Watt]	25-100	30-150	25-200
Crossover frequency [Hz]	3.000	2.000	800 / 2,200 / 14,000
Crossover principle	2-way	2-way	2½+½-way
High frequency driver	1 x 29 mm soft dome	1 x 29 mm soft dome	1 x 29 mm soft dome 1 x 17 x 45 mm ribbon
Low Frequency / mid-range Driver(s)	1 x 4¾"	1 x 6½"	2 x 6½"
Enclosure type	Bass reflex	Bass reflex	Bass reflex
Bass Reflex Tuning Frequency [Hz]	60	46	43,5
Connection Input(s)	Single	Single	Bi-wire / Bi-amp
Recommended placement	Stand/Shelf/Wall	Stand/Shelf	Floor
Recommended distance from rear wall to speaker's rear panel [cm]	2 - 80	10 - 80	20 - 100
Dimensions (H x W x D) [mm]	261 x 152 x 231	351 x 195 x 297	1001 x 195 x 330
Dimensions (H x W x D) [inches]	10,28 x 6,0 x 9,1	13,8 x 7,7 x 11,7	39,4 x 7,7 x 13,0
Weight [kg/lb]	4,9/ 10,8	9,2 / 20,3	19,3 / 42,5
Included accessories	Rubber feet, manual	Rubber feet, manual	Spike set, rubber feet, manual

	<b>OPTICON 8 MK2</b>	<b>OPTICON LCR MK2</b>	<b>OPTICON VOKAL MK2</b>
Frequency range (+/-3 dB) [Hz]	38 - 30.000	70 - 30.000	47 - 30.000
Sensitivity (2.83V/1m) [dB]	88,5	89	88
Nominal Impedance [ohm]	4	4	4
Maximum SPL [dB]	112	109	109
Recommended Amplifier Power [Watt]	40 - 300	30-150	30-150
Crossover frequency [Hz]	380 / 2,200 / 14,000	2.800 / 14.000	2.400 / 14.000
Crossover principle	3+½-way	2+½-way	2+½-way
High frequency driver	1 x 29 mm soft dome 1 x 17 x 45 mm ribbon	1 x 29 mm soft dome 1 x 17 x 45 mm ribbon	1 x 29 mm soft dome 1 x 17 x 45 mm ribbon
Low Frequency / mid-range Driver(s)	2 x 8" / 1 x 6½"	1 x 6½"	1 x 6½"
Enclosure type	Bass reflex (mid-range closed box)	Bass reflex	Bass reflex
Bass Reflex Tuning Frequency [Hz]	29,5	45	44
Connection Input(s)	Bi-wire / Bi-amp	Single	Single
Recommended placement	Floor	On-wall/Shelf	Shelf
Recommended distance from rear wall to speaker's rear panel [cm]	30 - 150	0 - 10	0 - 30
Dimensions (H x W x D) [mm]	1141 x 241x 450	482 x 285 x 128	201 x 435 x 312
Dimensions (H x W x D) [inches]	44,9 x 9,5 x 18,1	19 x 11,2 x 5	7,9 x 17,1 x 12,3
Weight [kg/lb]	37,1/ 81,8	9,1 / 20,1	10,6/ 23,4
Included accessories	Spike set, rubber feet, manual	Rubber feet, manual	Rubber feet, manual

All technical specifications are subject to change without notice.